

INSTALLATION INSTRUCTION

- 1 Sling
- 2 Suspension Wire
- 3 Rollerball barrel
- 4 Suspension Channel
- 5 Luminaire
- 6 End Plate (shown without magnetic cover plate)
- 7 Mounting surface
- 8 Beam or Support
- 9 Screw/Fixture

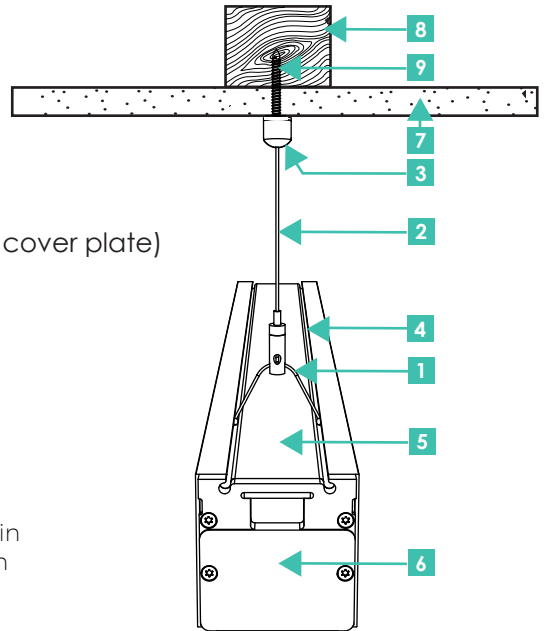

Installer must ensure that the slot orientation in ceiling barrel allows suspension wire to remain perpendicular at all times in all orientations

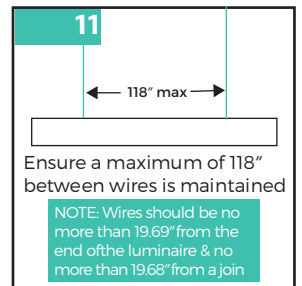
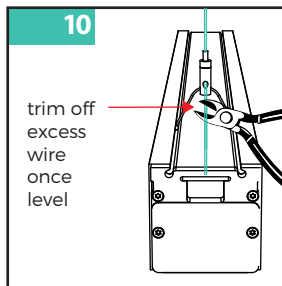
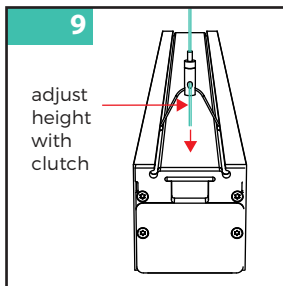
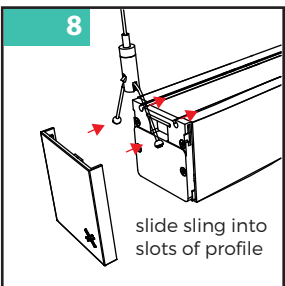
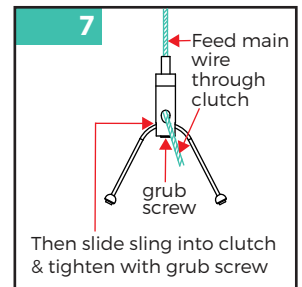
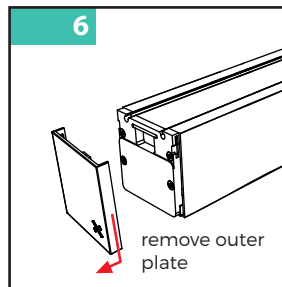
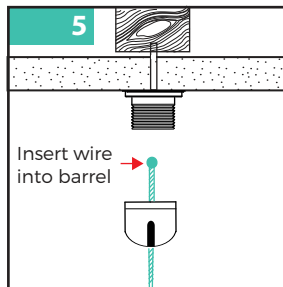
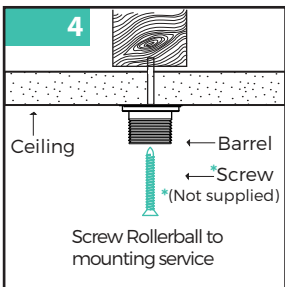
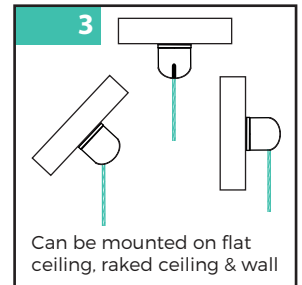
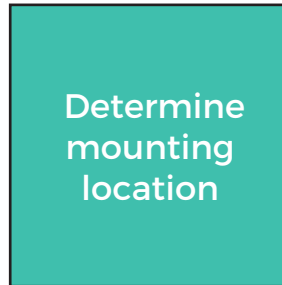
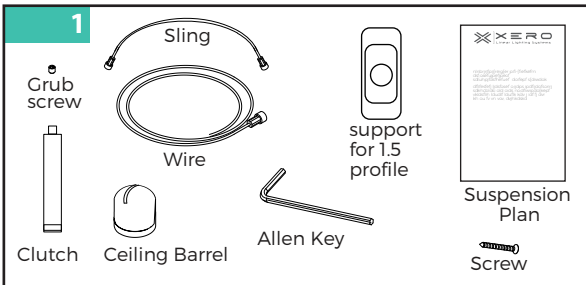

If more information is required please contact your local representative by going to xerolightingusa.com/contact or email us at xerolightingusa@xerolighting.com