

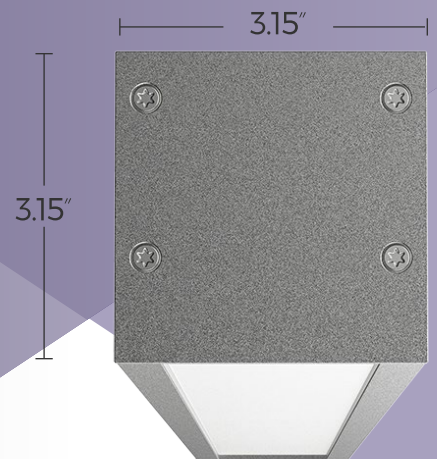

INFRASTRUCTURE

XTI | 3.0 SQUARE IK11 | IP66



XTI | 3.0 SQUARE

IK11 | IP66

DATA TABLE

Output	CRI:	80+
Warranty	ProformaxS	ProformaxS = 7years
Electrical	Voltage input range	120 - 277V
	Control methods	Dimming options for white light: 0-10V, DALI, DMX Optional RGB / Sunset Diming control DMX or DALI XI
	Approvals	UL / CE / CCC / AS:NZS / EMC
Physical	Dimensions	3.15"High x 3.15" Wide
	Weight per foot	(2.96lbs) average weight per foot
	Housing	Aluminium Extrusion with anodised or powder-coated finish Standard colours powder-coated: white/black/silver/ custom on request
	Diffuser	Polycarbonate Opal Diffuser/ Clear Polycarbonate Diffuser / Parabolic Louvre
	Connections	Optional IP Rated polarised electrical connection between sections
	Compatible ceiling type	Suitable for drywall ceilings, metal pan, concrete, timber and T bar grid ceilings
	Mounting	Field adjustable Rollerball Wire Suspensions / Surface Mounting / Custom Mounting / Rod Suspension / Wall Mounting
	Joiner options	90° / Straight / 180° / Custom
	Operating temperatures	ProformaxS (-13°F to 140°F)
	Environment	Luminaire IP66 (Not in direct sunlight, diffuser must not face upwards).
	IK rating	IK11
	Minimum length adjustment	5.51"
	LED Board types	ProformaxS boards and drivers in 3.93"/ 11.02"/ and 22.04" Zhaga compatible
	Vandal Proof	Available with Anti-Vandal Fasteners
Optional Extras	Lanyards / Emergency packs / Camera / Environmental Plugs / Thermal throttle / IOT connectivity / Anti-Graffiti / Self Cleaning Coating / Halogen Free Diffuser / Anti Bird Roosting /	

XTI | 3.0 SQUARE

IK11 | IP66

XTI AVAILABLE LENGTHS

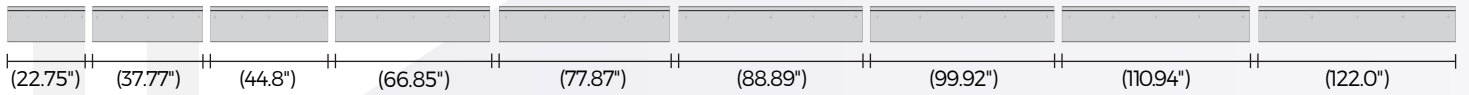

EXAMPLE OF A STANDARD LENGTH COMBINATION

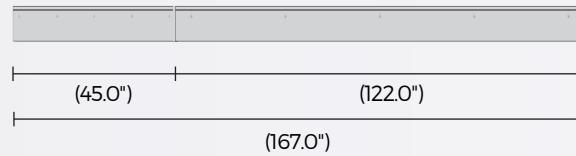

CREATING LENGTHS WITH XTI | 3.0 SQUARE IP66 | IK11

The XTI | 3.0 Square IP66 | IK11 set lengths can be coupled together in any combination to achieve the desired length.
Note: Custom lengths are also available - Please consult your local office for information

JOINING CONFIGURATION

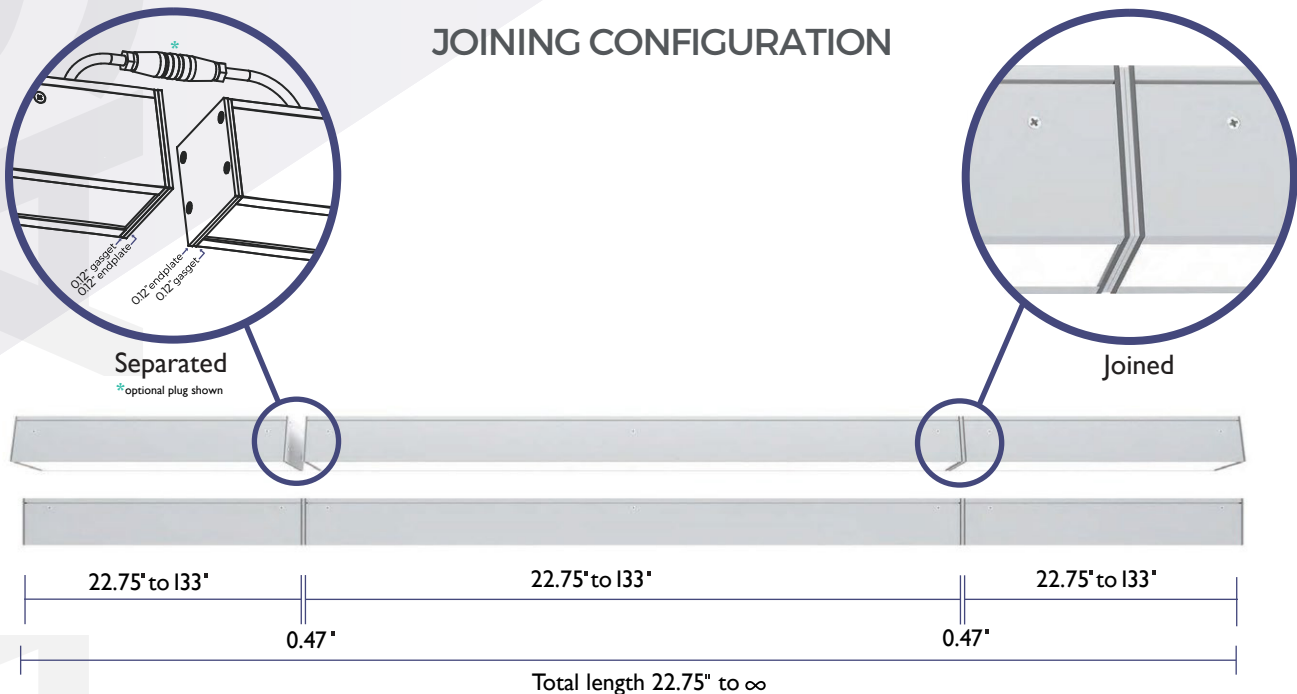

XTI | 3.0 SQUARE

IK11 | IP66

Optical control

XTI profiles come with many diffuser options for glare control in any application



sensors / daylight harvesting



emergency packs



Polycarbonate



Semi-specular louvre



Optic white louvre

Accessories



pa speaker



ewis speaker



smoke detector



camera

Mounting Options

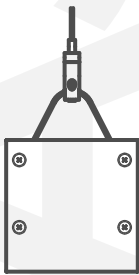

Wire Suspension

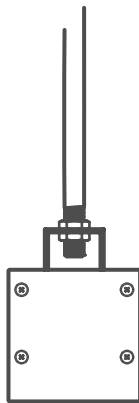

Rod Suspension

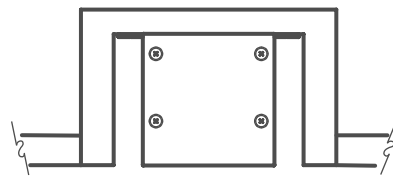

Recessed Mounting
(ceiling trough by others)

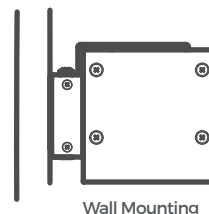

Wall Mounting
(side view)

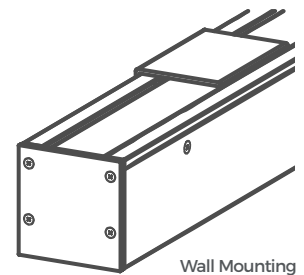

Wall Mounting

Options Guide

Profile	Length	Diffuser	Color	Mounting	Color Temp	Driver	Whip Length	Extras
XTI 3.0 Square XTI3	22.75"	Opal Polycarbonate	White WH	Wire Suspension WS	3K	Fixed FO	36"	Lanyards L
	33.77"	Parabolic Louvre	Black BL	Rod suspension RD	3.5K	DALI D	72"	Emergency pack EM
	44.8"	Anodised NA	Anodised NA	Sliding Surface Plates SP	4K	O-10V O10	108"	Self clean coating SCC
	66.85"		Custom C	Wall mounting WALL			144"	Halogen free diffuser HF
	77.87"							
	88.89"							
	99.92"							
	110.94"							
	122"							
EG order code: XTI3/44.8/WH/SP/3K/FO/36/EM								